

IPv6 Technology Overview Tutorial- Part I



Speaker: Byju Pularikkal

Customer Solutions Architect, Cisco Systems Inc.

Acronyms/Abbreviations

- DOCSIS = Data-Over-Cable Service Interface Specification
- CMTS = Cable Modem Termination System
- DS = Downstream
- US = Upstream
- CM = Cable Modem
- IPv6 = Internet Protocol version 6
- ICMPv6 = Internet Control Message Protocol version 6
- DHCPv6 = Dynamic Host Configuration Protocol for IPv6
- MSO = Multiple Services Operator
- SMB = Small Business
- PDA = Personal Digital Assistant
- NAT = Network Address Translation
- CIDR = Classless Interdomain Routing
- DAD = Duplicate Address Detection
- SLA = Subnet Level Address
- VPN = Virtual Private Network
- ARP = Address Resolution Protocol
- eSAFE = Embedded Service/Application Functional Entity
- RS = Router Solicitation
- RA = Router Advertisement
- UDP = User Datagram Protocol
- DUID = DHCP Unique Identifier
- DNS = Domain Name System
- CPE = Customer Premises Equipment
- ND = Neighbor Discovery
- NS = Neighbor Solicitation
- HFC = Hybrid Fiber Coaxial
- EUI = Extended Unique Identifier
- TFTP = Trivial File Transfer Protocol
- ToD = Time of Day
- MDD = Mac Domain Descriptor
- APM = Alternative Provisioning Mode
- SNMP = Simple Network Management Protocol
- ASM = Anysource Multicast
- SSM = Source Specific Multicast
- SLAAC = Stateless Address Autoconfiguration
- MLD = Multicast Listener Discovery

Tutorial-1: Agenda

- Structure of IPv6 Protocol
 - IPv4 and IPv6 Header Comparison
 - IPv6 Extension Headers
- IPv6 Addressing
 - Addressing Format
 - Types of IPv6 addresses
- ICMPv6 and Neighbor Discovery
 - Router Solicitation & Advertisement
 - Neighbor Solicitation & Advertisement
 - Duplicate Address Detection
- Multicast in IPv6
- DHCP & DNS for IPv6
 - DNS with IPv6
 - DHCPv6 Overview

Tutorial-2: Agenda

- Routing in IPv6
 - RIPng
 - OSPFv3
 - BGP-4 Extensions for IPv6
 - Multi-Topology IS-IS
- Tunneling
 - Automatic 6 to 4 Tunnels
 - ISATAP
- IPv6 for DOCSIS Overview
 - IPv6 Drivers in Broadband Access Networks
 - CMTS & CM Requirements for IPv6
 - MSO CPE Address Assignment Strategies

The Structure of IPv6 Protocol



IPv4 and IPv6 Header Comparison

IPv4 Header

Version	IHL	Type of Service	Total Length	
Identification		Flags	Fragment Offset	
Time to Live	Protocol	Header Checksum		
Source Address				
Destination Address				
Options			Padding	

IPv6 Header

Version	Traffic Class	Flow Label		
Payload Length		Next Header	Hop Limit	
Source Address				
Destination Address				

Legend

- Field name kept from IPv4 to IPv6
- Fields not kept in IPv6
- Name and position changed in IPv6
- New field in IPv6

IPv6 Header New Field—Flow Label (RFC 3697)

20-Bit Flow Label Field to Identify Specific Flows Needing Special QoS

- Flow classifiers had been based on 5-tuple: Source/destination address, protocol type and port numbers of transport
- Some of these fields may be unavailable due to fragmentation, encryption or locating them past extension headers
- With flow label, each source chooses its own flow label values; routers use source addr + flow label to identify distinct flows
- Flow label value of 0 used when no special QoS requested (the common case today)

IPv6 Header

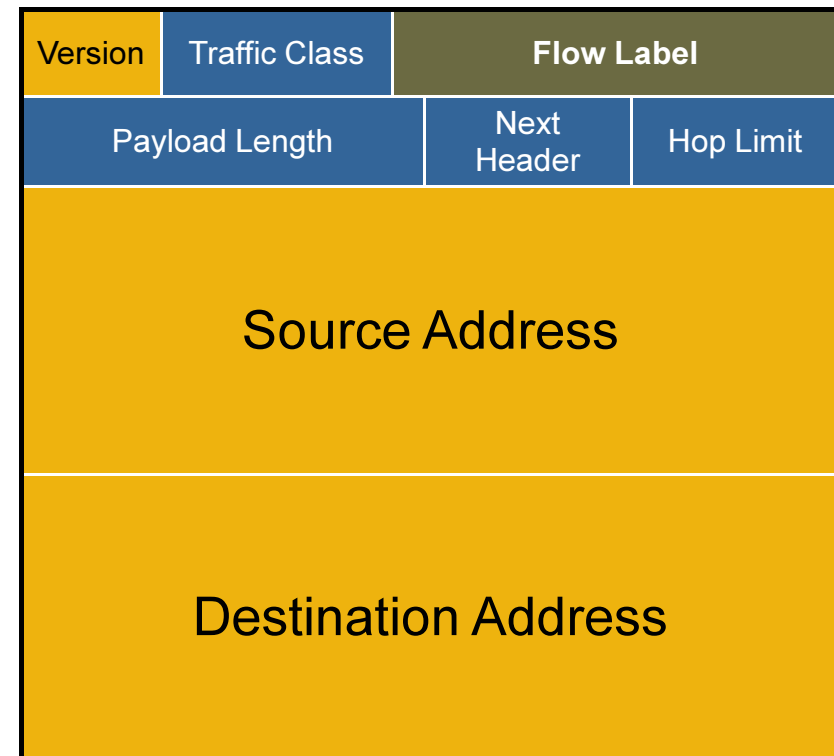

Extension Headers

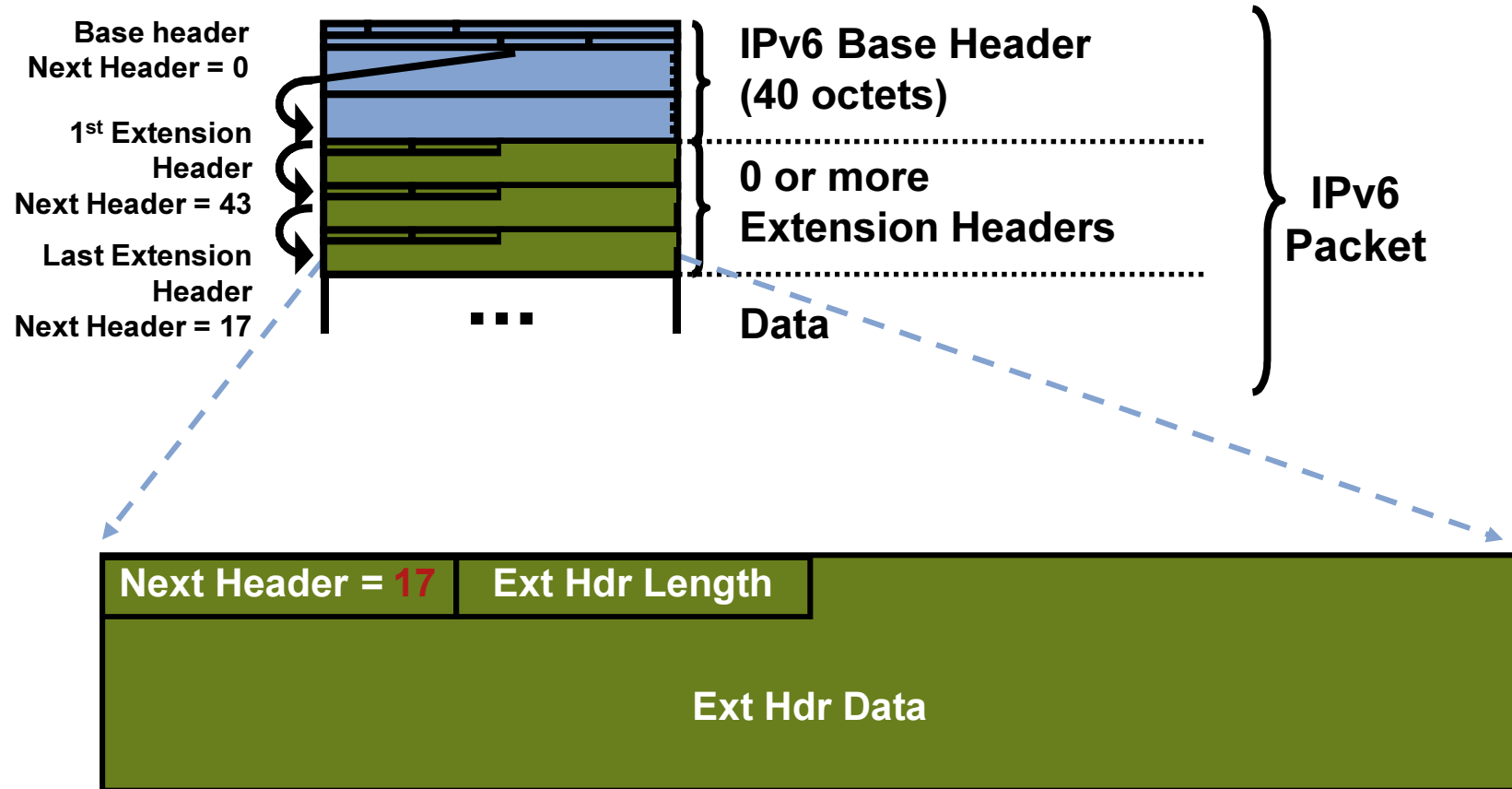

Extension Header Order

Extension Headers Should Be Constructed in the Following Sequence and Should Be Sequenced in this Order:

Hop-by-Hop header	(0)
Destination options header (w/ routing header)	(60)
Routing header	(43)
Fragment header	(44)
Authentication header	(51)
ESP header	(50)
Mobility header	(135)
Destination options header	(60)
ICMPv6	(58)
No Next header	(59)
Upper-layer header	(Varies— TCP=6, UDP=17)

MTU Issues

- Minimum link MTU for IPv6 is 1280 octets (vs. 68 octets for IPv4)
 - ⇒ on links with MTU < 1280, link-specific fragmentation and reassembly must be used
- Implementations are expected to perform path MTU discovery to send packets bigger than 1280
- Minimal implementation can omit PMTU discovery as long as all packets kept ≤ 1280 octets
- A hop-by-hop option supports transmission of “jumbograms” with up to 2^{32} octets of payload; payload is normally 2^{16}

IPv6 Addressing



IPv6 Addressing

IPv4 32-bits

IPv6 128-bits

$$2^{32} = 4,294,967,296$$

$$2^{128} = 340,282,366,920,938,463,463,374,607,431,768,211,456$$

$$2^{128} = 2^{32} * 2^{96}$$

$$2^{96} = 79,228,162,514,264,337,593,543,950,336 \text{ times the number of possible IPv4 Addresses (79 trillion trillion)}$$

IPv6 Addressing

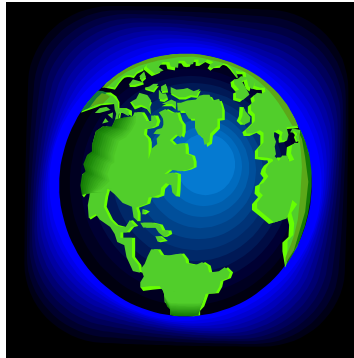

World's population is approximately 6.5 billion

$$\frac{2^{128}}{6.5 \text{ Billion}} = 52 \text{ Trillion Trillion IPv6 addresses per person}$$



Typical brain has ~100 billion brain cells (your count may vary)

$$\frac{52 \text{ Trillion Trillion}}{100 \text{ Billion}} = 523 \text{ Quadrillion (523 thousand trillion) IPv6 addresses for every human brain cell on the planet!}$$

Addressing Format

Representation

- 16-bit hexadecimal numbers
- Numbers are separated by (:)
- Hex numbers are not case sensitive
- Abbreviations are possible

Leading zeros in contiguous block could be represented by (::)

Example:

`2001:0db8:0000:130F:0000:0000:087C:140B`

`2001:0db8:0:130F::87C:140B`

Double colon only appears once in the address

Addressing

Prefix Representation

- Representation of prefix is just like CIDR
- In this representation you attach the prefix length
- Like v4 address:
`198.10.0.0/16`
- V6 address is represented the same way:
`2001:db8:12::/48`
- Only leading zeros are omitted. Trailing zeros are not omitted
`2001:0db8:0012::/48 = 2001:db8:12::/48`
`2001:db8:1200::/48 ≠ 2001:db8:12::/48`

IPv6 Address Representation

- Loopback address representation

0:0:0:0:0:0:0:1=> ::1

Same as 127.0.0.1 in IPv4

Identifies self

- Unspecified address representation

0:0:0:0:0:0:0:0=> ::

Used as a placeholder when no address available

(Initial DHCP request, Duplicate Address Detection DAD)

IPv6—Addressing Model

- Addresses are assigned to interfaces

Change from IPv4 mode:

- Interface “expected” to have multiple addresses

- Addresses have scope

Link Local

Unique Local

Global

- Addresses have lifetime

Valid and preferred lifetime

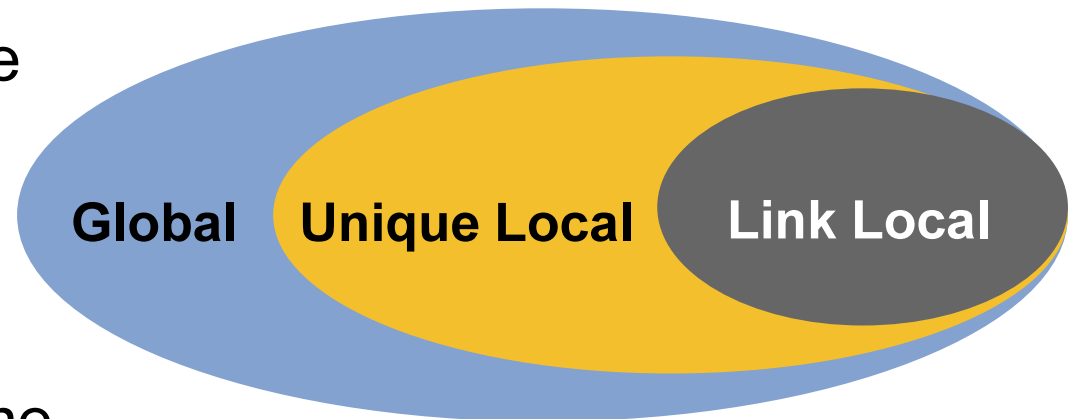

Addressing

Some Special Addresses

Type	Binary	Hex
Aggregatable Global Unicast Address	001	2 or 3
Link Local Unicast Address	1111 1110 10	FE80::/10
Unique Local Unicast Address	1111 1100 1111 1101	FC00::/7 FC00::/8(registry) FD00::/8 (no registry)
Multicast Address	1111 1111	FF00::/8

Types of IPv6 Addresses

- Unicast

Address of a single interface. One-to-one delivery to single interface

- Multicast

Address of a set of interfaces. One-to-many delivery to all interfaces in the set

- Anycast

Address of a set of interfaces. One-to-one-of-many delivery to a single interface in the set that is closest

- No more broadcast addresses

Global Unicast Addresses

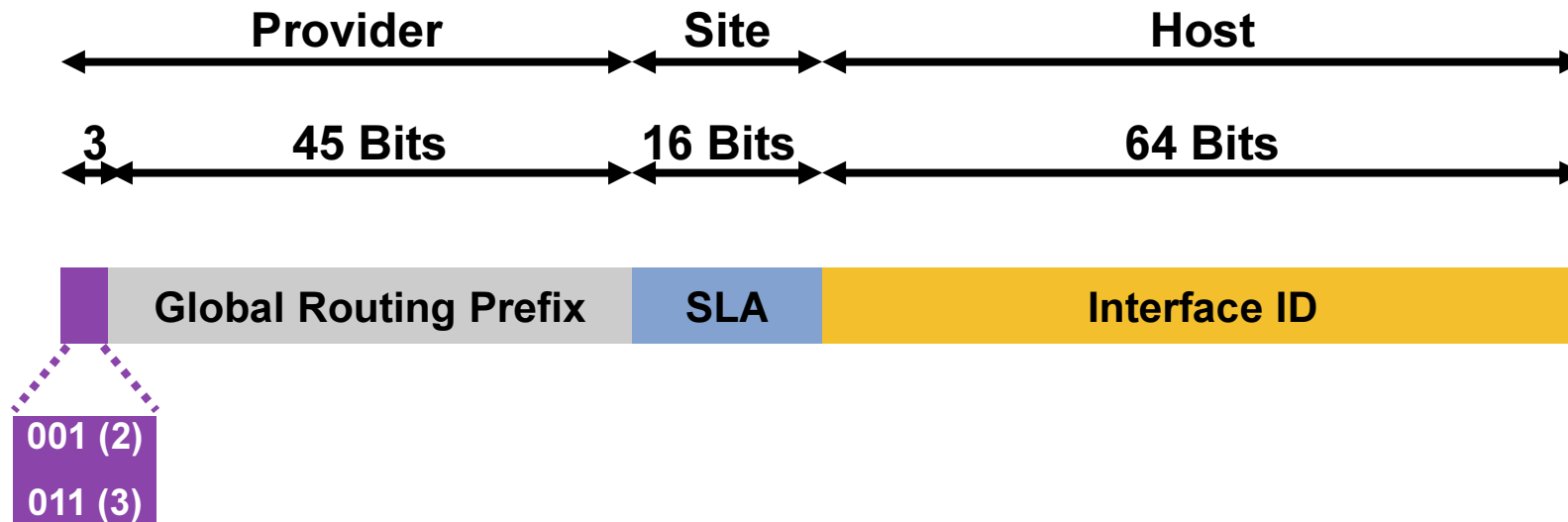

Global Unicast Addresses Are:

- Addresses for generic use of IPv6
- Structured as a hierarchy to keep the aggregation

Unique-Local

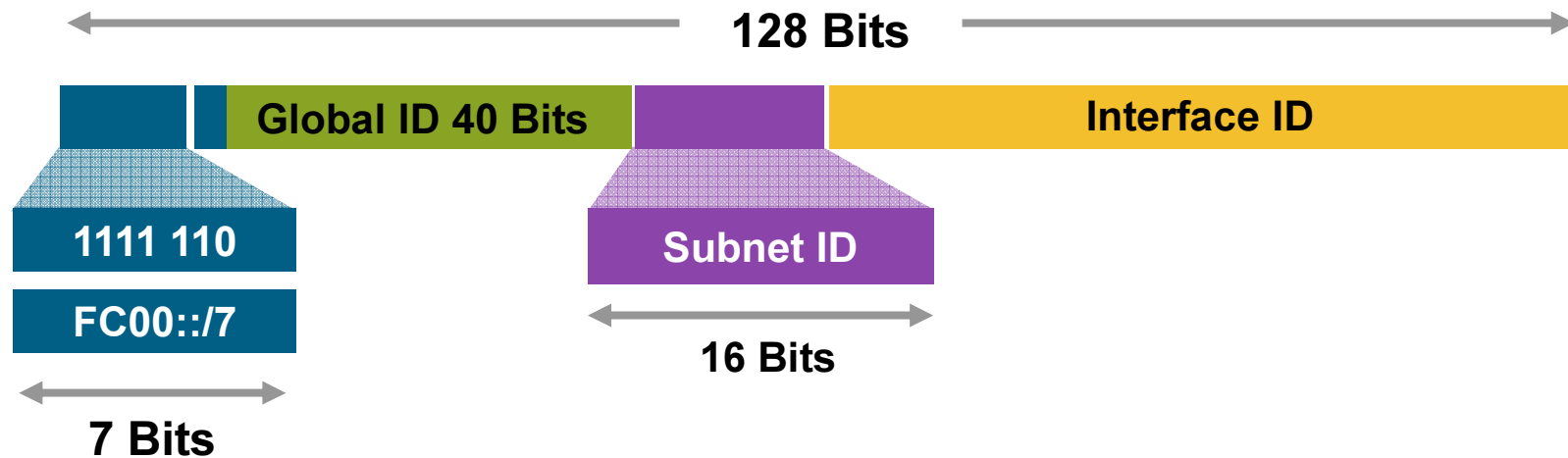

Unique-Local Addresses Used for:

- Local communications
- Inter-site VPNs
- Not routable on the Internet

Link-Local

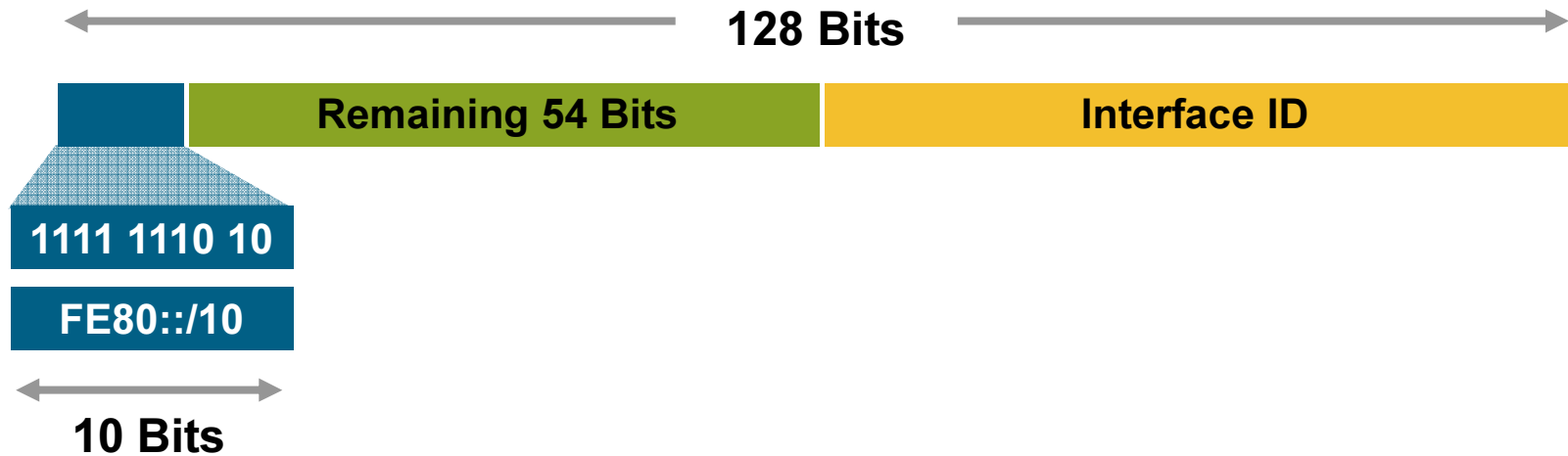

Link-Local Addresses Used for:

- Mandatory Address for Communication between two IPv6 device (like ARP but at Layer 3)
- Automatically assigned by Router as soon as IPv6 is enabled
- Also used for Next-Hop calculation in Routing Protocols
- Only Link Specific scope
- Remaining 54 bits could be Zero or any manual configured value

IPv6 Multicast Address

- IP multicast address has a prefix FF00::/8 (1111 1111); the second octet defines the lifetime and scope of the multicast address

8-bit	4-bit	4-bit	112-bit
1111 1111	Lifetime	Scope	Group-ID

Lifetime	
0	If Permanent
1	If Temporary

Scope	
1	Node
2	Link
5	Site
8	Organization
E	Global

Some Well Known Multicast Addresses

Address	Scope	Meaning
FF01::1	Node-Local	All Nodes
FF02::1	Link-Local	All Nodes
FF01::2	Node-Local	All Routers
FF02::2	Link-Local	All Routers
FF05::2	Site-Local	All Routers
FF02::1:FFXX:XXXX	Link-Local	Solicited-Node

- Note that 02 means that this is a permanent address and has link scope
- More details at <http://www.iana.org/assignments/ipv6-multicast-addresses>

Multicast Mapping over Ethernet

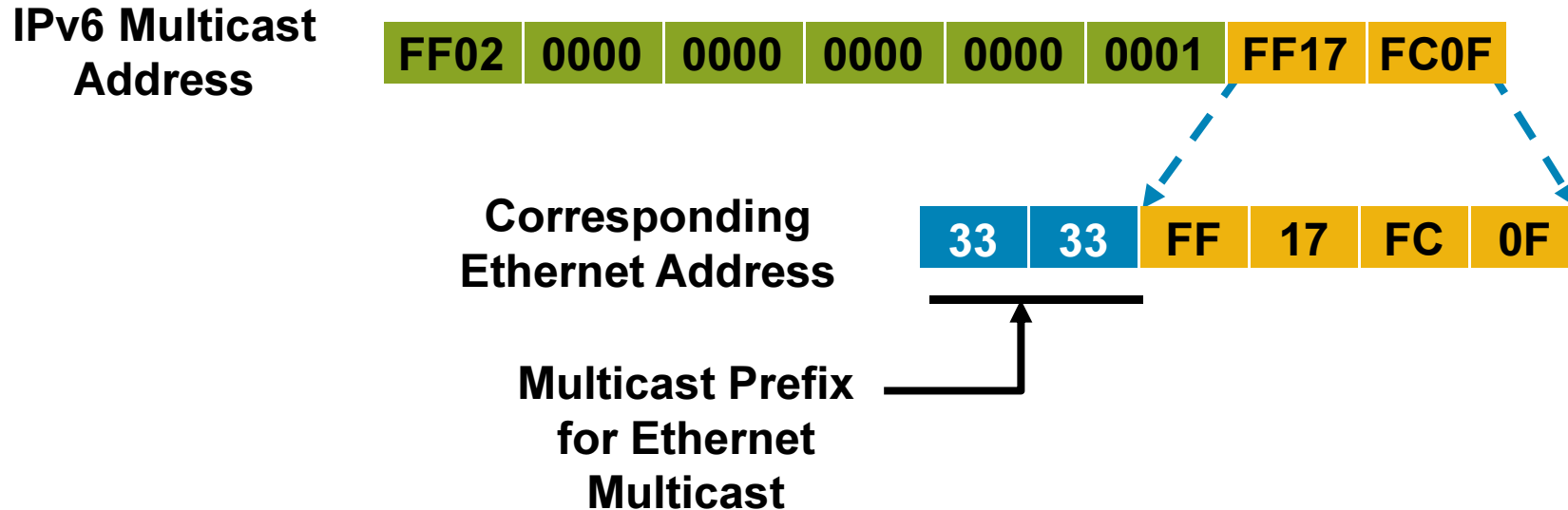

- Mapping of IPv6 multicast address to Ethernet address is:

33:33:<last 32 bits of the IPv6 multicast address>

Solicited-Node Multicast Address

- For each unicast and anycast address configured there is a corresponding solicited-node multicast
- This is specially used for two purpose, for the replacement of ARP, and DAD
- Used in neighbor solicitation messages
- Multicast address with a link-local scope
- Solicited-node multicast consists of prefix + lower 24 bits from unicast, FF02::1:FF:

IPv6 Address

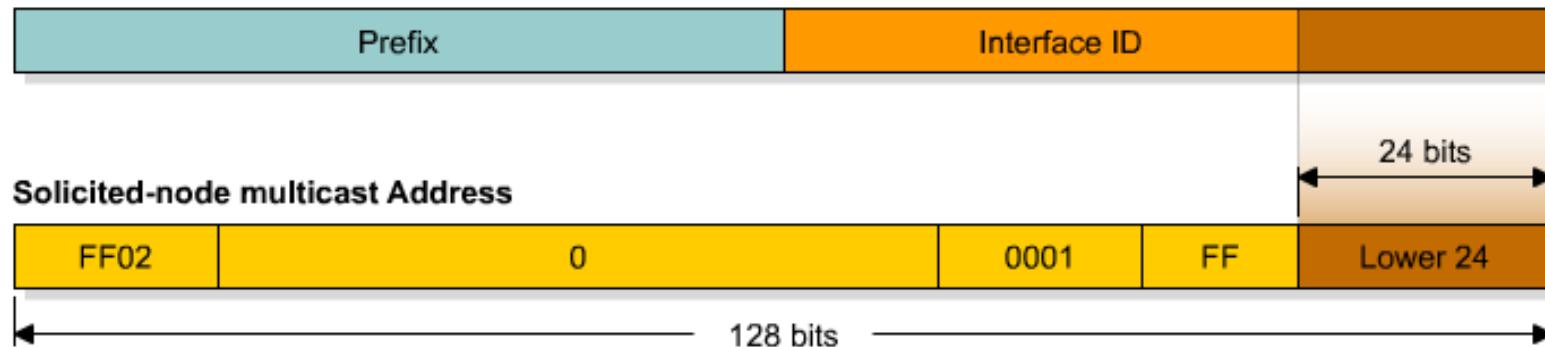

Anycast

Anycast Address Assignment

- Anycast allows a source node to transmit IP datagrams to a single destination node out of a group destination nodes with same subnet id based on the routing metrics
- Only routers should respond to anycast addresses
- Routers along the path to the destination just process the packets based on network prefix
- Routers configured to respond to anycast packets will do so when they receive a packet send to the anycast address

Anycast Address

Subnet Router Anycast Address (RFC 4291)

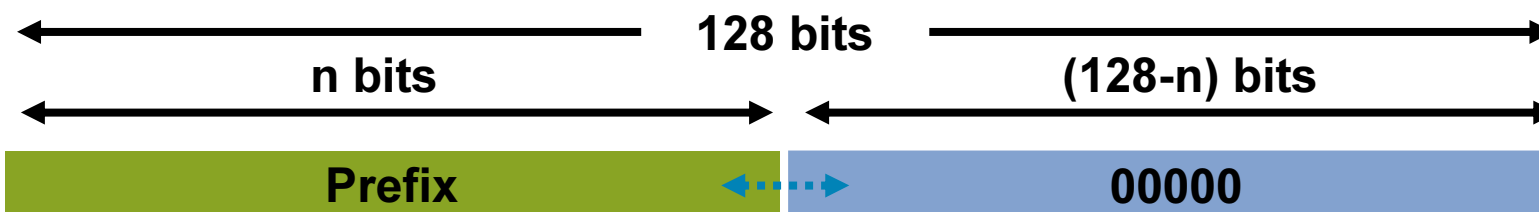

Reserved Subnet Anycast Address (RFC 2526)

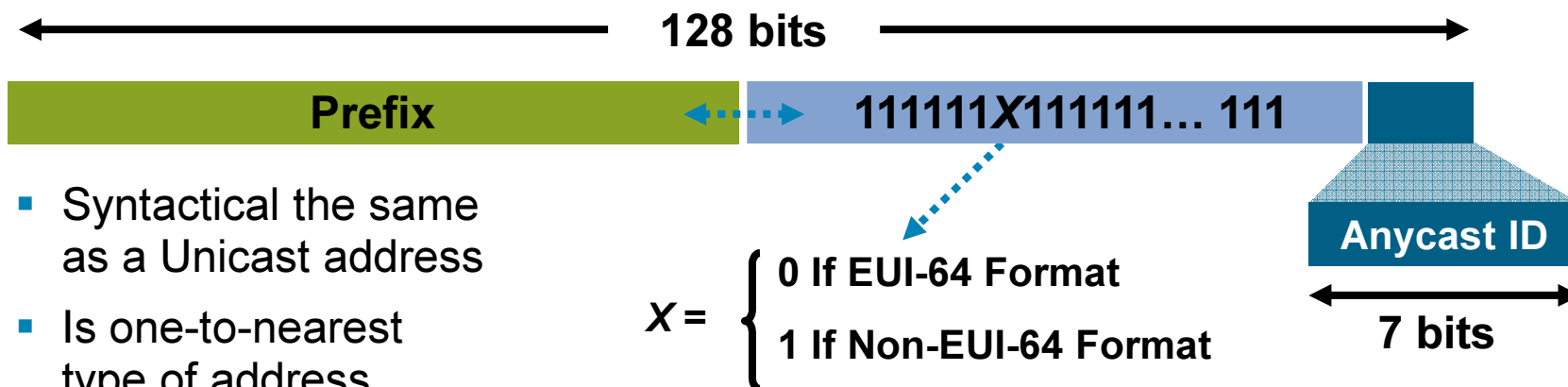

- Syntactical the same as a Unicast address
- Is one-to-nearest type of address
- Has a current limited use

- Use Example: Mobile IPv6 Home-Agent Anycast Address

IPv6 Prefix Allocation Hierarchy and Policy Example

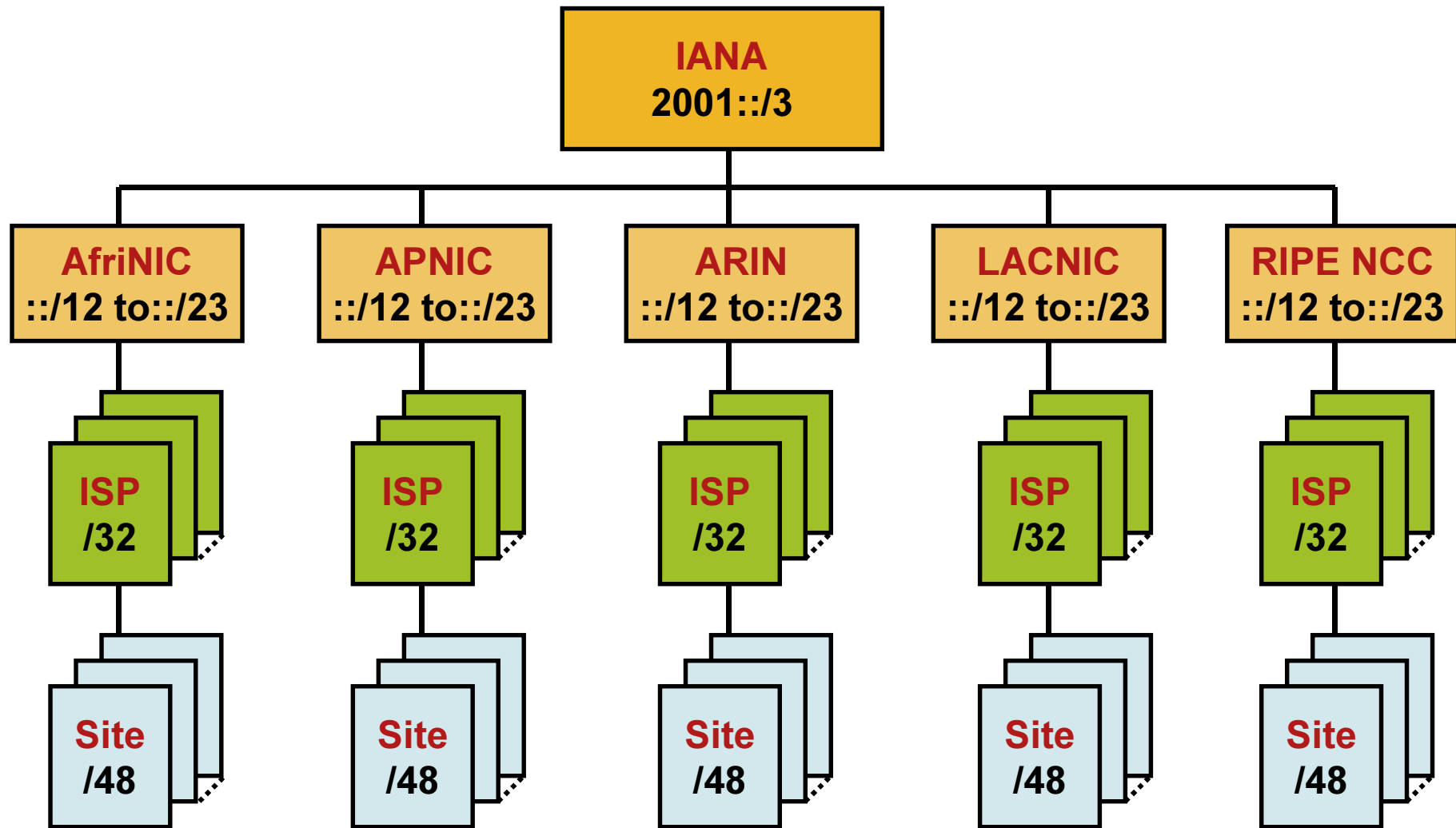

IPv6 Address Allocation Process

Partition of Allocated IPv6 Address Space

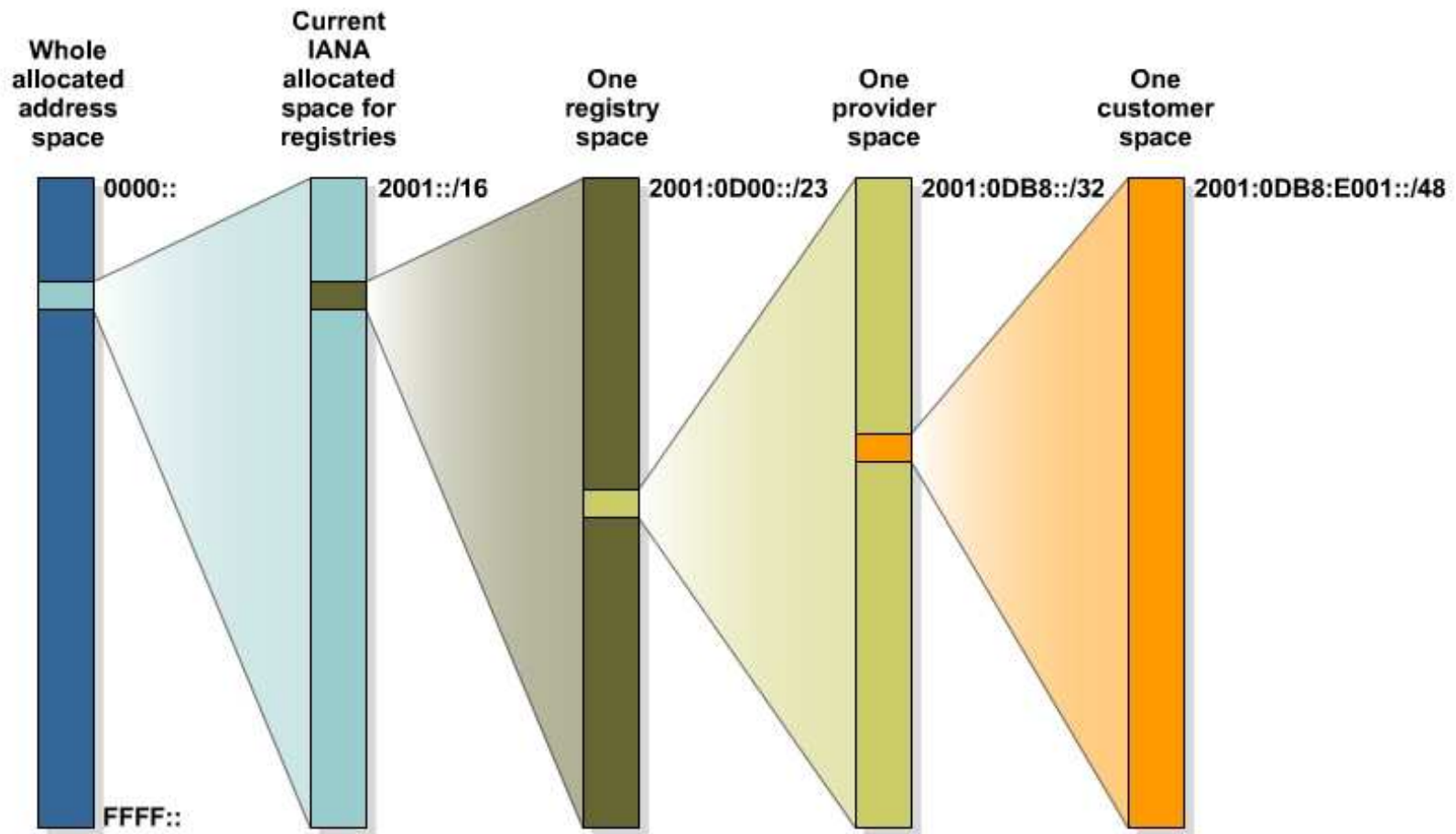

IPv6 Address Allocation Process

Partition of Allocated IPv6 Address Space (Cont.)

- Lowest-Order 64-bit field of unicast address may be assigned in several different ways:
 - Auto-configured from a 64-bit EUI-64, or expanded from a 48-bit MAC address (e.g., Ethernet address)
 - Auto-generated pseudo-random number (to address privacy concerns)
 - Assigned via DHCP
 - Manually configured

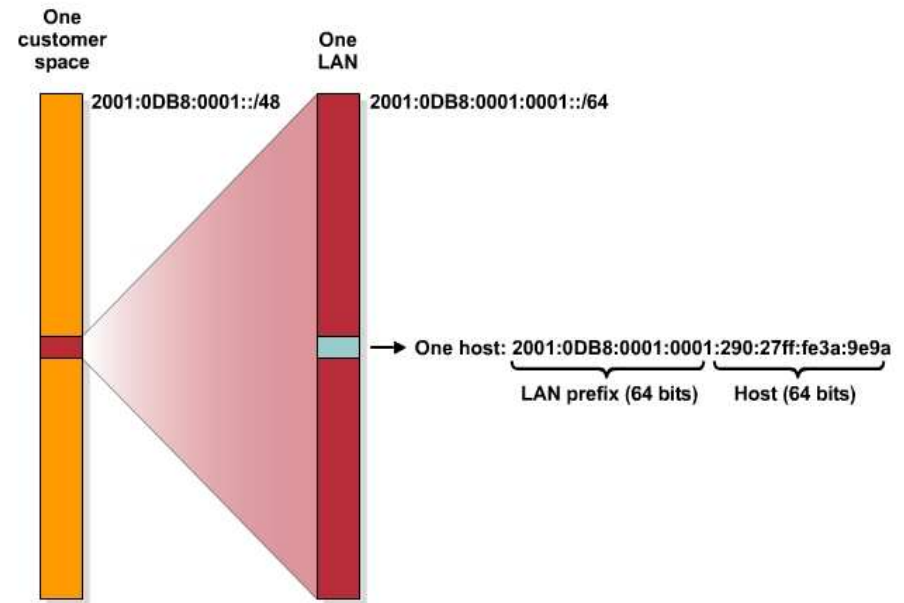

IPv6 Interface Identifier

- Cisco uses the EUI-64 format to do stateless auto-configuration
- This format expands the 48 bit MAC address to 64 bits by inserting FFFE into the middle 16 bits
- To make sure that the chosen address is from a unique Ethernet MAC address, the universal/local (“u” bit) is set to 1 for global scope and 0 for local scope

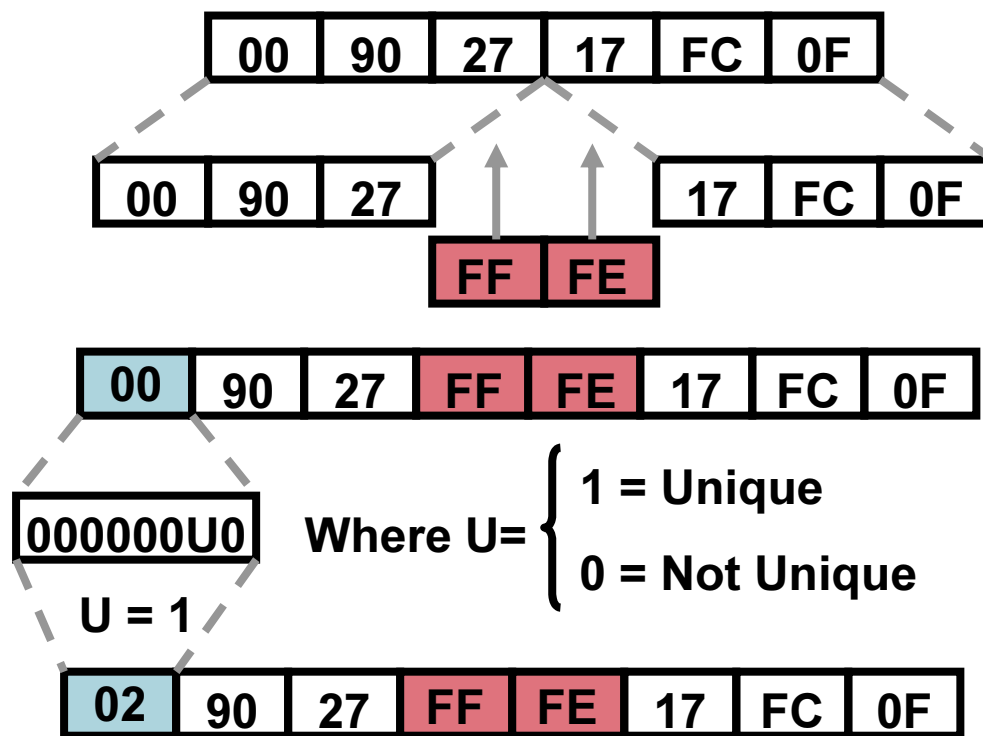

ICMPv6 and Neighbor Discovery



ICMPv6

- Internet Control Message Protocol version 6
- RFC 2463
- Modification of ICMP from IPv4
- Message types are similar
(but different types/codes)
 - Destination unreachable (type 1)
 - Packet too big (type 2)
 - Time exceeded (type 3)
 - Parameter problem (type 4)
 - Echo request/reply (type 128 and 129)

ICMPv6 Message Fields

- **Type**—identifies the message or action needed
- **Code**—is a type-specific sub-identifier. For example, Destination Unreachable can mean no route, port unreachable, administratively prohibited, etc.
- **Checksum**—computed over the entire ICMPv6 message and **prepended** with a pseudo-header containing a single-octet
- **Next Header** in ipv6 will have a value of 58 for icmp

Neighbor Discovery

- Replaces ARP, ICMP (redirects, router discovery)
- Reachability of neighbors
- Hosts use it to discover routers, auto configuration of addresses
- Duplicate Address Detection (DAD)

Neighbor Discovery : Contd..

- Neighbor discovery uses ICMPv6 messages, originated from node on link local with hop limit of 255
- Consists of IPv6 header, ICMPv6 header, neighbor discovery header, and neighbor discovery options
- Five neighbor discovery messages
 1. Router solicitation (ICMPv6 type 133)
 2. Router advertisement (ICMPv6 type 134)
 3. Neighbor solicitation (ICMPv6 type 135)
 4. Neighbor advertisement (ICMPv6 type 136)
 5. Redirect (ICMPV6 type 137)

Router Solicitation and Advertisement



1—ICMP Type = 133 (RS)

Src = link-local address (FE80::1/10)

Dst = all-routers multicast address (FF02::2)

Query = please send RA

2—ICMP Type = 134 (RA)

Src = link-local address (FE80::2/10)

Dst = all-nodes multicast address (FF02::1)

Data = options, subnet prefix, lifetime, autoconfig flag

- Router solicitations (RS) are sent by booting nodes to request RAs for configuring the interfaces
- Routers send periodic Router Advertisements (RA) to the all-nodes multicast address

Neighbor Solicitation and Advertisement



Neighbor Solicitation

ICMP type = 135

Src = A

Dst = Solicited-node multicast of B

Data = link-layer address of A

Query = what is your link address?



Neighbor Advertisement

ICMP type = 136

Src = B

Dst = A

Data = link-layer address of B



A and B can now exchange packets on this link

A large horizontal double-headed arrow spanning the width of the diagram, indicating that A and B can now exchange packets on this link.

Multicast Neighbor Solicitation – for Duplicate Address Detection (DAD)

Ethernet Header

- Dest MAC is 33-33-**FF-52-F9-D8**

IPv6 Header

- Source Address is ::
- Destination Address is FF02::1:**FF52:F9D8**
- Hop limit is 255

Neighbor Solicitation Header

- Target Address is
FE80::2:260:8FF:FE52:F9D8

Host A



Tentative IP: FE80::2:260:8FF:FE52:F9D8

① Send multicast Neighbor Solicitation



Host B

Host A uses DAD to verify the existence of a duplicate address before assigning the address to its interface.

Multicast Neighbor Advertisement (Response)

Ethernet Header

- Destination MAC is 33-33-00-00-00-01

IPv6 Header

- Source Address is FE80::2:260:8FF:FE52:F9D8
- Destination Address is FF02::1
- Hop limit is 255

Neighbor Advertisement Header

- Target Address is FE80::2:260:8FF:FE52:F9D8

Neighbor Discovery Option

- Target Link-Layer Address is 00-60-08-52-F9-D8

Host A

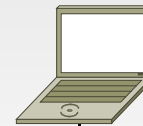

Tentative IP: FE80::2:260:8FF:FE52:F9D8



Redirect

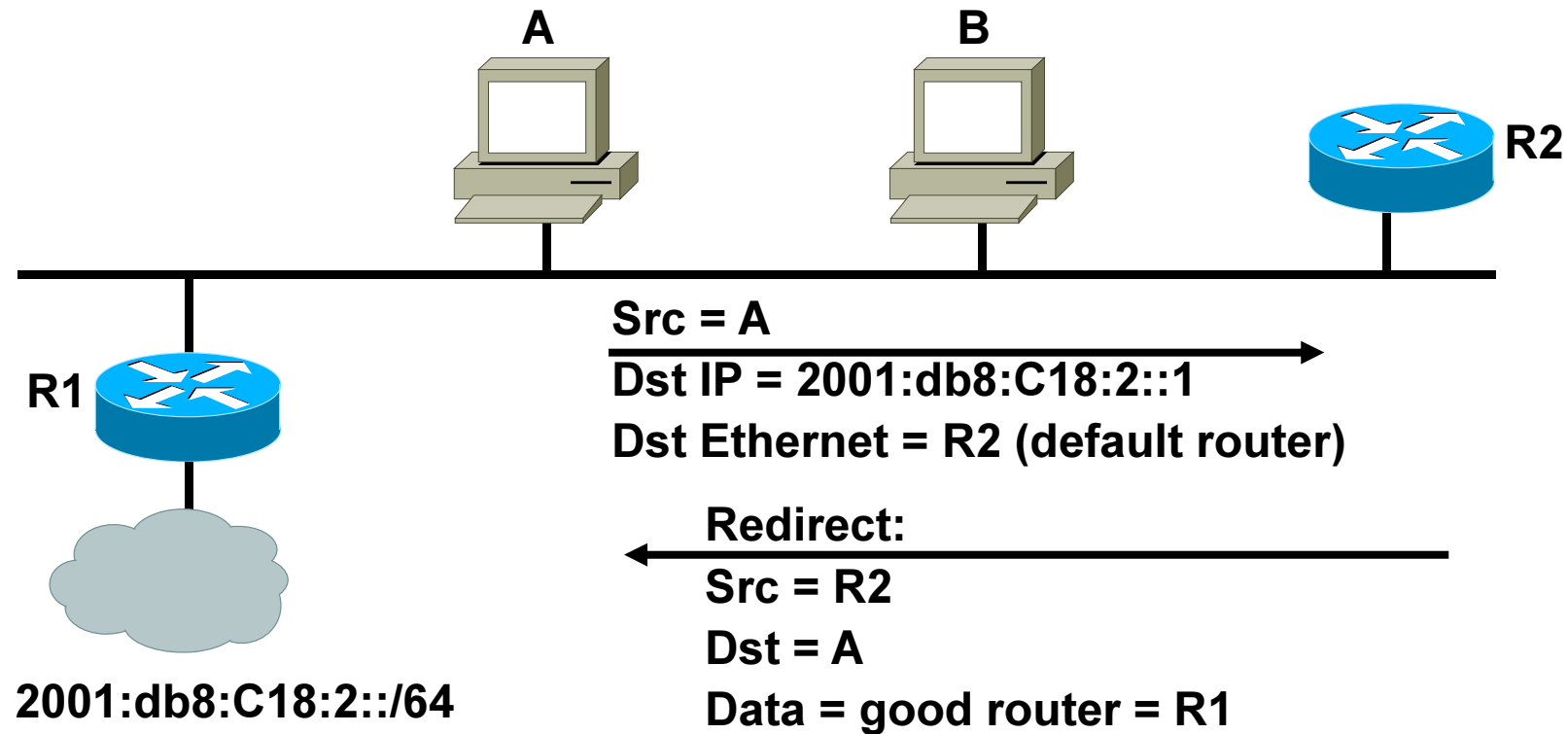

- Redirect is used by a router to signal the reroute of a packet to a better router

Autoconfiguration

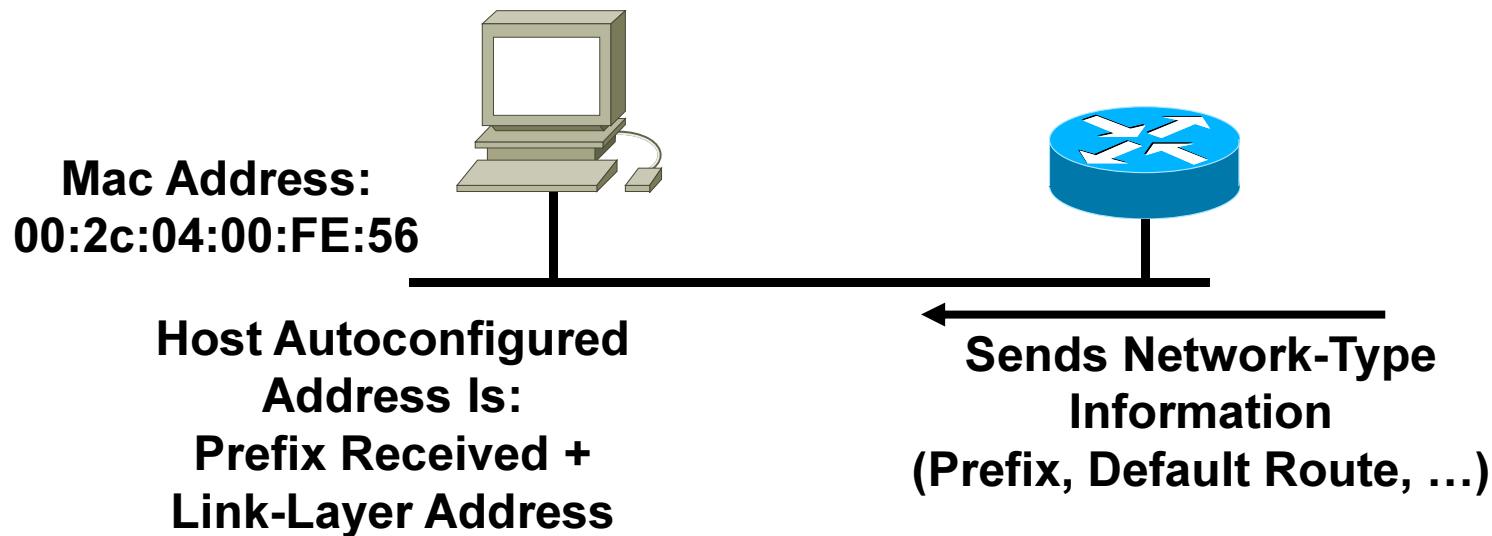

Larger Address Space Enables:

- The use of link-layer addresses inside the address space
- Autoconfiguration with “no collisions”
- Offers “plug and play”

Renumbering

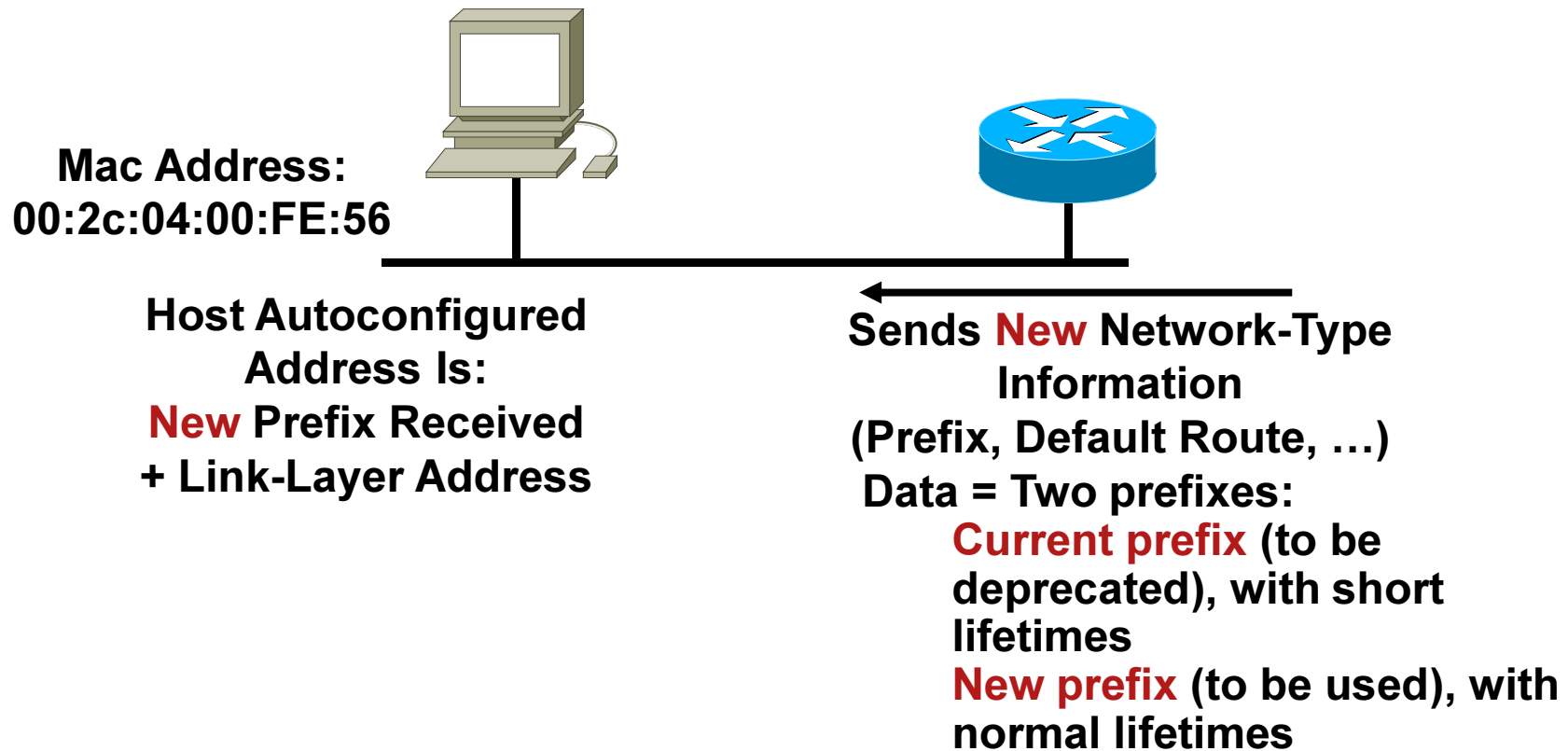

Larger Address Space Enables:

- Renumbering, using autoconfiguration and multiple addresses

Renumbering (Cont.)

Router Configuration after Renumbering:

```
interface Ethernet0
  ipv6 nd prefix 2001:db8:c18:1::/64 43200 0
  ipv6 nd prefix 2001:db8:c18:2::/64 43200 43200
```

or:

```
interface Ethernet0
  ipv6 nd prefix 2001:db8:c18:1::/64 at Jul 31 2008 23:59 Jul 20 2008 23:59
  ipv6 nd prefix 2001:db8:c18:2::/64 43200 43200
```

New Network Prefix: 2001:db8:c18:2::/64

Deprecated Prefix: 2001:db8:c18:1::/64



← Router Advertisements

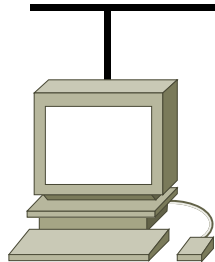

Autoconfiguring
IPv6 Hosts

Host Configuration:

```
deprecated address 2001:db8:c18:1:260:8ff:fede:8fbe
preferred address 2001:db8:c18:2:260:8ff:fede:8fbe
```

IPv6 Multicast Service Models

- ASM – Any Source Multicast
(Traditionally just called PIM-SM)
 - Service description: RFC1112 (no update for IPv6 done yet)
 - MLDv1 RFC2710 or MLDv2 draft-vida-mld-v2-xx.txt
 - PIM-Sparse Mode (PIM-SM) draft-ietf-pim-sm-v2-new-xx.txt
 - Bidirectional PIM (PIM-bidir) draft-ietf-pim-bidir-xx.txt
- SSM – Source Specific Multicast
 - Service description (IPv4/IPv6): draft-ietf-ssm-overview-xx.txt
 - MLDv2 required
 - PIM-SSM – not a separate protocol, just a subset of PIM-SM !
 - Unicast prefix based multicast addresses ff30::/12
 - SSM range is ff3X::/32, current allocation is from ff3X::/96

Multicast Listener Discover – MLD

- Equivalent to IGMP in IPv4
- Messages are transported over ICMPv6
- Uses link local source addresses
- Use “Router Alert” option in header (RFC2711)
- Version number confusion:
 - MLDv1 (RFC2710) like IGMPv2 (RFC2236)
 - MLDv2 (draft-vida-mld-v2-07) like IGMPv3 (RFC3376)
 - Provides SSM support
- MLD snooping (RFC 4541)

MLD - Joining a Group (REPORT)

FE80::209:5BFF:FE08:A674

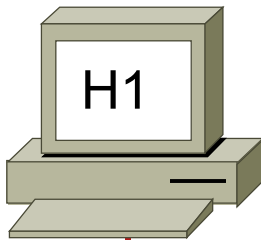

FE80::250:8BFF:FE55:78DE

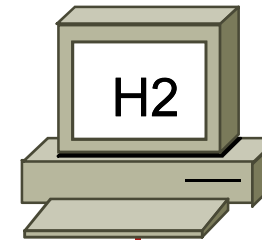

1

Destination:
FF3E:40:3FFE:C15:C003:1109:1111:1111
ICMPv6 Type: 131

2

Destination:
FF3E:40:3FFE:C15:C003:1109:1111:1111
ICMPv6 Type: 131

1

H1 sends a REPORT for the group

2

H2 sends a REPORT for the group



FE80::207:85FF:FE80:692

Source

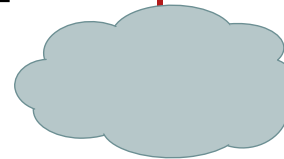

Group:FF3E:40:3FFE:C15:C003:1109:1111:1111

MLD - Group-Specific Query

FE80::209:5BFF:FE08:A674

FE80::250:8BFF:FE55:78DE

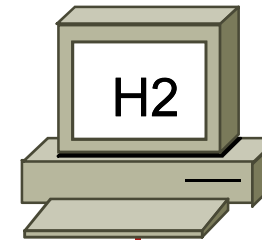
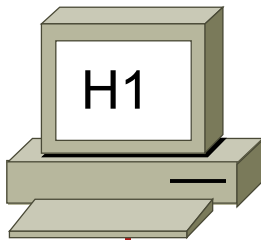

3 REPORT to group
ICMPv6 Type: 131



1 Destination:
FF02::2
ICMPv6 Type: 132

2 Destination:
FF3E:40:3FFE:C15:C003:1109:1111:1111
ICMPv6 Type: 130

- 1 H1 sends DONE to FF02::2
- 2 RTR-A sends Group-Specific Query
- 3 H2 sends REPORT for the group



FE80::207:85FF:FE80:692

Source



Group:FF3E:40:3FFE:C15:C003:1109:1111:1111

Other MLD Operations

- Leave/DONE
 - Last host leaves - Sends DONE (Type 132)
 - Router responds with Group-Specific Query (Type 130)
 - Router uses the Last member query response interval (Default=1 sec) for each query
 - Query is sent twice and if no reports occur then entry is removed (2 seconds)

- General Query (Type 130)
 - Sent to learn of listeners on the attached link
 - Sets the Multicast Address Field to zero
 - Sent every 125 seconds (configurable)

DHCP and DNS for IPv6



DNS Basics

- DNS is a database managing Resource Records (RR)
 - Stockage of RR from various types—IPV4 and IPV6:
 - Start of Authority (SoA)
 - Name Server
 - Address—A and AAAA
 - Pointer—PTR
- DNS is an IP application
 - It uses either UDP or TCP on top of IPv4 or IPv6
- References
 - RFC3596: DNS Extensions to Support IP Version 6
 - RFC3363: Representing Internet Protocol Version 6 Addresses in Domain Name system (DNS)
 - RFC3364: Tradeoffs in Domain Name System (DNS) Support for Internet Protocol version 6 (IPv6)

DHCPv6 Overview

- Updated version of DHCP for IPv4
- Supports new addressing
- Can be used for renumbering
- DHCP Process is same as in IPv4
- Client first detect the presence of routers on the link
- If found, then examines router advertisements to determine if DHCP can be used
- If no router found or if DHCP can be used, then
 - DHCP Solicit message is sent to the All-DHCP-Agents multicast address
 - Using the link-local address as the source address
- Multicast addresses used:
 - FF02::1:2 = All DHCP Agents (servers or relays, Link-local scope)
 - FF05::1:3 = All DHCP Servers (Site-local scope)
 - DHCP Messages: Clients listen UDP port 546; servers and relay agents listen on UDP port 547

DHCPv6 – Overview

- Supports IPv6 addressing and configuration needs
- Is the “Stateful” auto-configuration protocol for IPv6
- Is the “other” (non-address) configuration protocol for IPv6
- Supports “prefix delegation”, not just “address assignment”
- Clean design:
 - New optimized packet format (no BOOTP legacy)
 - 16-bit option space, 16-bit option lengths
 - Uses encapsulation (some messages/options encapsulate others)
 - Client may obtain many addresses (not just one)
 - Client and server use DUID (DHCP Unique Identifier)
 - Relay agent **always** involved (unless server allows otherwise)
 - Client has link-local address so can communicate on-link
 - Link-local multicasting used (client to relay/server)
 - Server to client or relay to client communication via link-local unicast

Why DHCPv6 when IPv6 stateless auto-configuration exists

- Stateless auto-configuration only configures addresses; not “other configuration” information (DNS servers, domain search list, ...)
- Stateless auto-configuration is “one-size fits all”
 - Addresses can not be selectively assigned
 - Policies can not be enforced about clients allowed addresses

IPv6 Autoconfiguration & DHCPv6

- Stateless Autoconfiguration – RFC 3736
 - Sometimes called DHCPv6lite
 - The DHCPv6 server does not assign addresses but instead provides configuration parameters, such as DNS server information, to these clients
 - Very similar to DHCPv4 DHCPINFORM/DHCPACK
- Stateful configuration – RFC 3315
 - The DHCPv6 server assigns (non-temporary and/or temporary) addresses and provides configuration parameters to clients
- Prefix Delegation (PD) – RFC 3633
 - The DHCPv6 server delegates prefixes to clients (i.e., routers) instead of leasing addresses
- One, two, or all three may be used at the same time on different prefixes

Who Am I - DHCP Unique Identifier

- Used by client and server to identify themselves
- Should be stable “forever”
- Three types defined in RFC 3315
 1. Link-layer address plus time (DUID-LLT)
 2. Vendor-assigned unique ID based on Enterprise ID (DUID-EN)
 3. Link-layer address (DUID-LL)

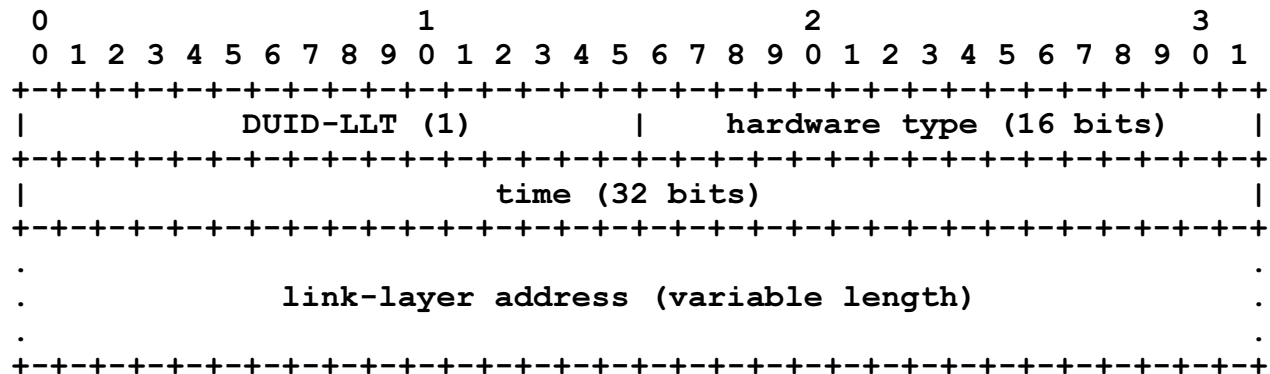

DHCPv6 – Client/Server Messages

- Basic message format (UDP, ports 546 and 547)

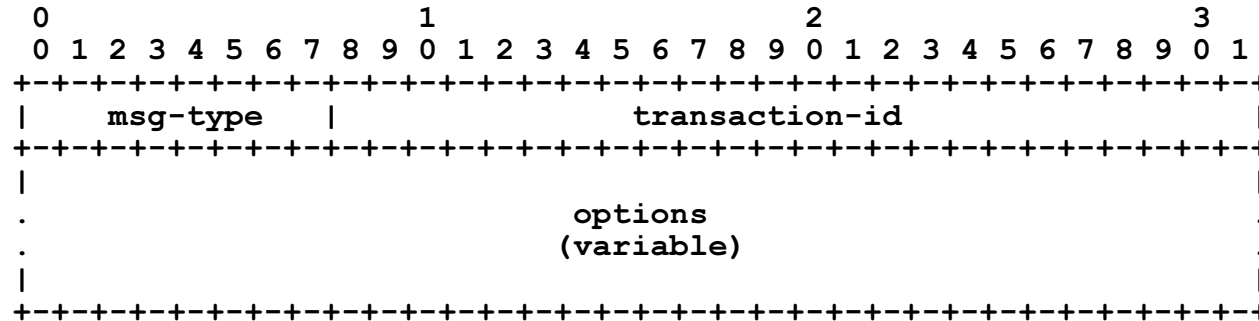

- Message Types

Client -> Server: Solicit, Request, Confirm, Renew, Rebind, Release, Decline, Information-Request

Server -> Client: Advertise, Reply, Reconfigure

Relay -> Relay/Server: Relay-Forw

Server/Relay -> Relay: Relay-Reply

Note: Relay-Forw and Relay-Reply have different format (except msg-type field)

- Options used to carry all data (minimal fixed fields)

DHCPv6 versus DHCPv4 Message Types

DHCPv6 Message Type	DHCPv4 Message Type
Solicit (1)	DHCPDISCOVER
Advertise (2)	DHCPOFFER
Request (3), Renew (5), Rebind (6)	DHCPREQUEST
Reply (7)	DHCPACK / DHCPNAK
Release (8)	DHCPRELEASE
Information-Request (11)	DHCPINFORM
Decline (9)	DHCPDECLINE
Confirm (4)	none
Reconfigure (10)	DHCPFORCERENEW
Relay-Forw (12), Relay-Reply (13)	none

Confirm Message

- Used by Client when:
 - it detects link-layer connectivity change (reconnect to link)
 - It is powered on and one or more leases still valid
- Allows client to confirm if still on the same link
- Any server can reply with Success or Not-On-Link status
 - **Success** means the addresses' prefixes are valid
 - **Not-on-Link** means one or more prefixes is not valid
 - Note: Does NOT indicate if lease(s) themselves are valid; just the prefixes!

DHCPv6 - Options

- 16-bit option numbers
 - Options may appear multiple times (are **not** concatenated)
- 16-bit option lengths
- Some option encapsulated other options
 - Relay messages encapsulate client (or other relay) messages in a Message option
 - IA_NA, IA_TA, and IA_PD options encapsulate addresses and delegated prefixes
- Client **MUST** include options desired from server in ORO

Router Advertisement

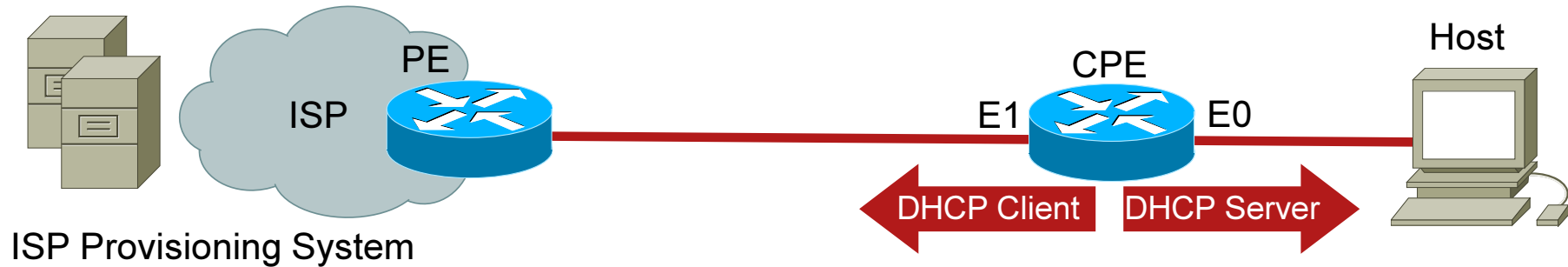

Source of RA	User of RA	A Bit		M/O Bits	
		A	Operation	M/O	Operation
PE	CPE E1	0	Don't Do Stateless Address Assignment	11	Use Dhcpv6 for Address + Other Config. (i.e., Stateful Dhcpv6)
CPE Router	Host	1	Do Stateless Address Assignment	01	Use Dhcpv6 for Other Config. (i.e., Stateless Dhcpv6)

Stateless (RFC2462)

RS Are Sent by Booting Nodes to Request RAs for Configuring the Interfaces; Host Autonomously Configures Its Own Link-Local Address

Prefix/Options Assignment

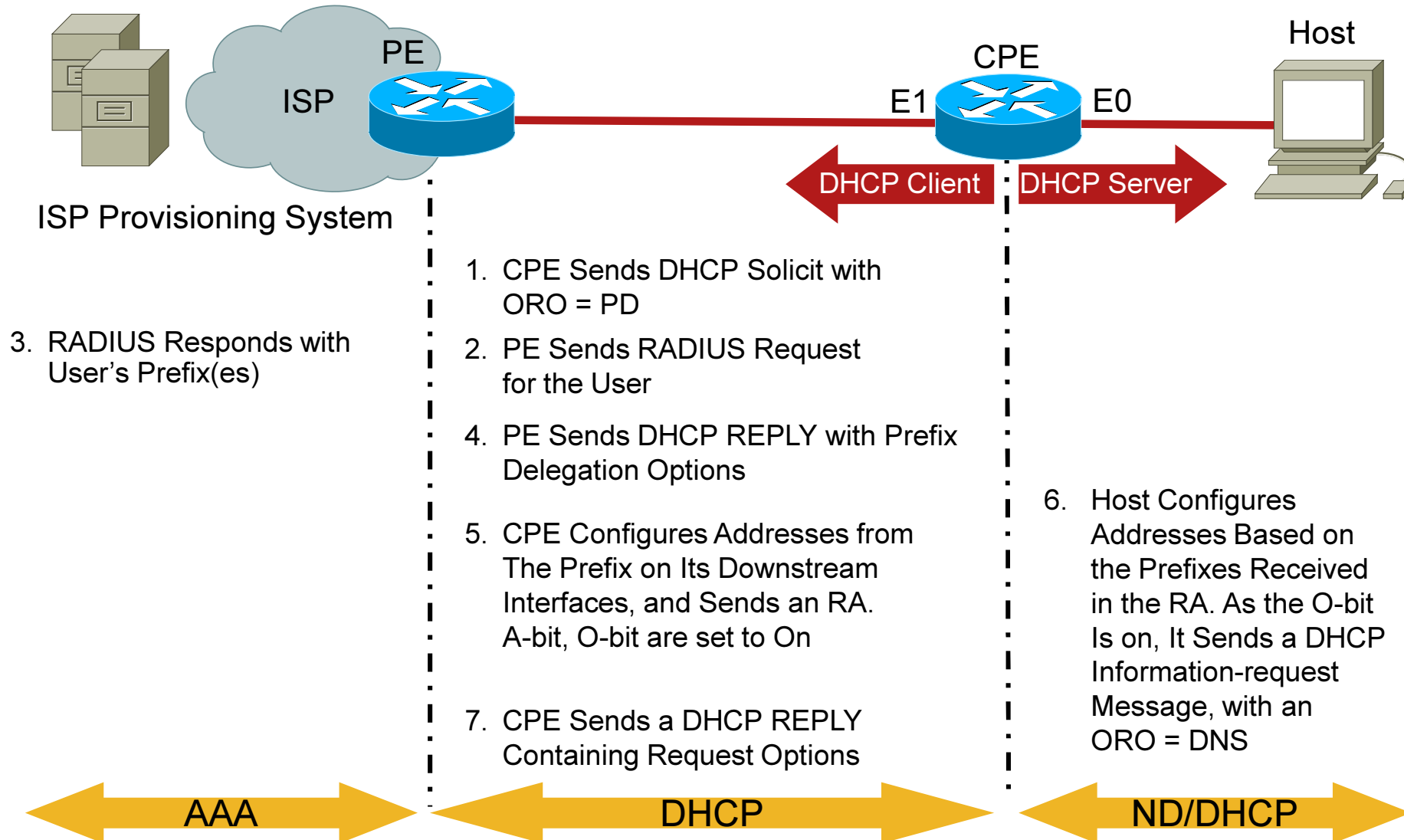

DHCPv6 Operation

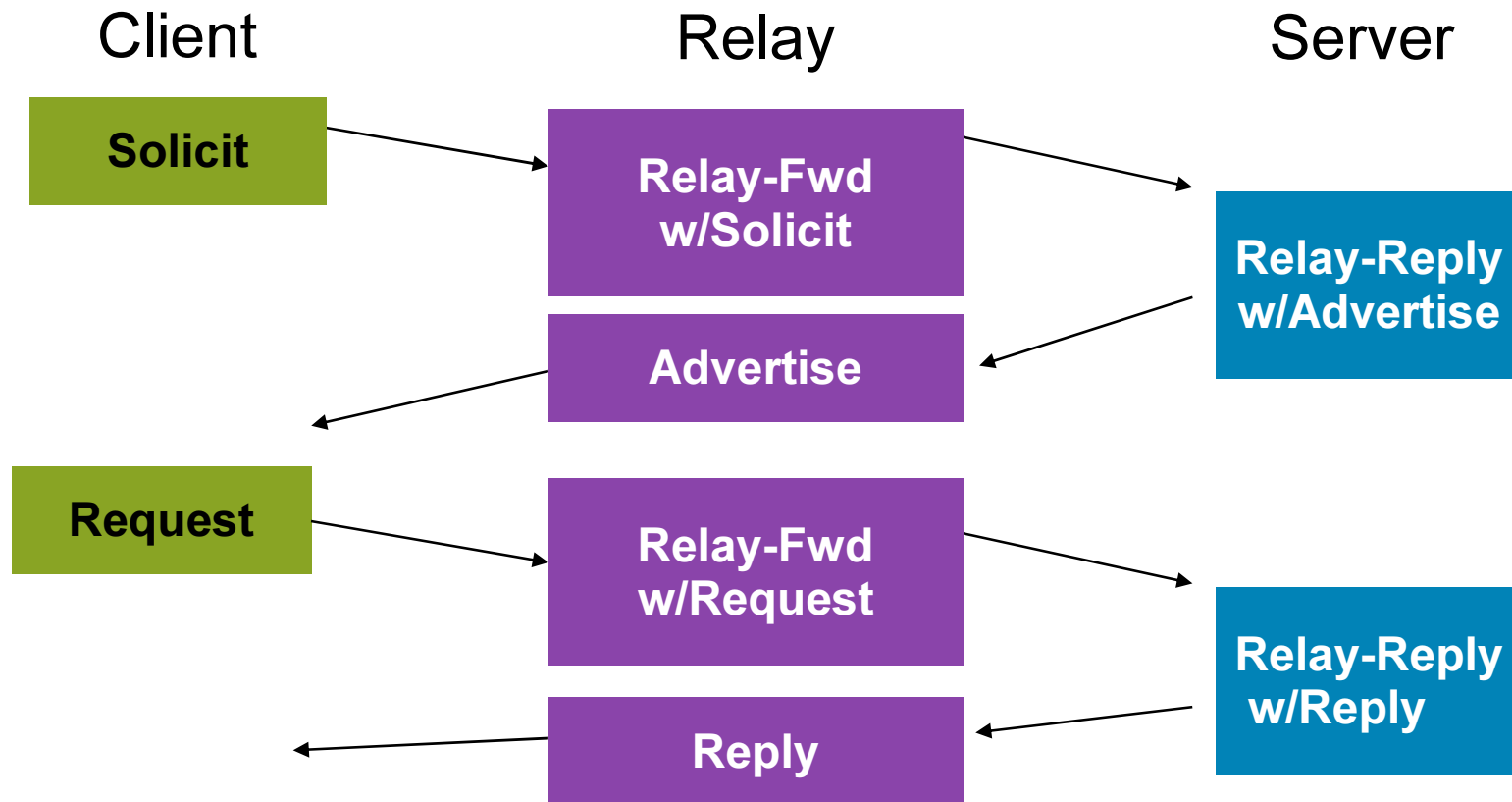

- All_DHCP_Relay_Agents_and_Servers (FF02::1:2)
- All_DHCP_Servers (FF05::1:3)
- DHCP Messages: Clients listen UDP port 546; servers and relay agents listen on UDP port 547

Q & A

